

Article number: 2310308071ESD

Description: E+G Antistatic base for levelling elements
LV.A-70-14-AS-M12x98-ESD-C

Measures

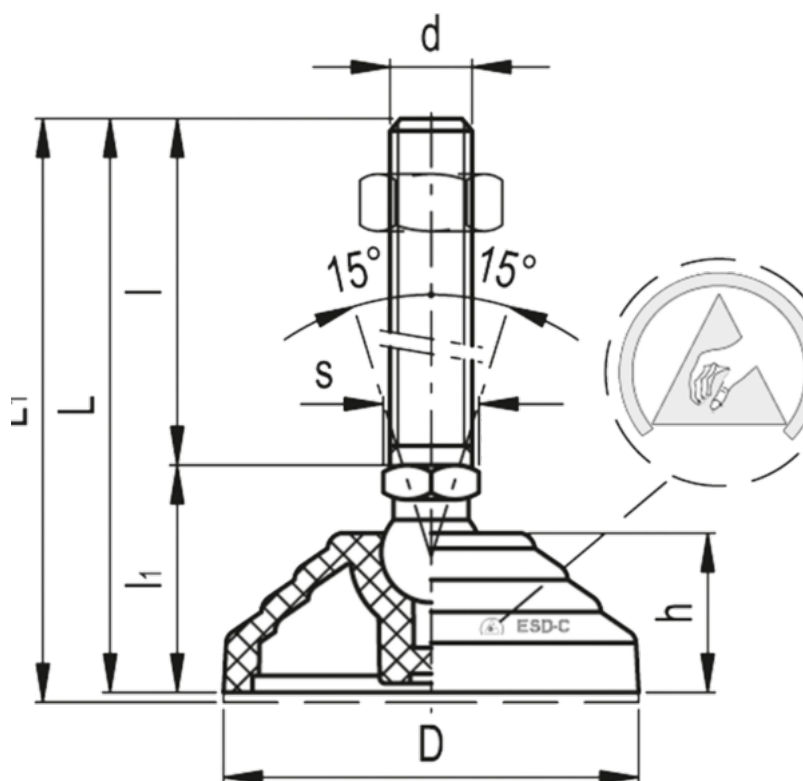

Articulation	= 14	Max load	= 14000
D	= 70	s	= 14
d	= M12	Weight in (g)	= 137
h	= 19		
l	= 98		
l1	= 28		
L	= 126		
L1	= 129		